

High Speed Remote I/O Module

EXF-RC15

The Unitronics EXF-RC15 is a High Speed Remote I/O Module that offers three High Speed Counter inputs and four high speed outputs. Overall, the EXF-RC15 offers 9 digital inputs, 4 digital transistor outputs and 2 relay outputs. It connects to the Vision controller via CANbus and can be easily programmed via a USB port.

Component Identification

- 1 Status indicators
- 2 CANbus port
- 3 Output points
- 4 Input points
- 5 USB port
- 6 Power supply connection points

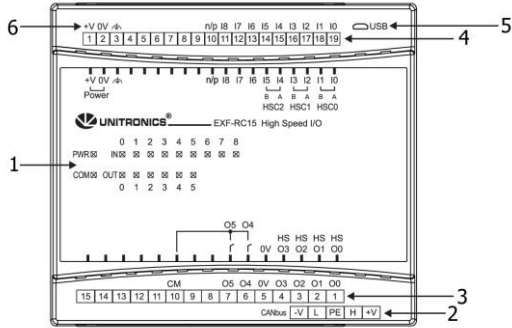

Standard Kit Contents

- 2 I/O terminal blocks
- 1 CANbus terminal block
- 1 CANbus termination resistor

High Speed Remote I/O Module Diagram

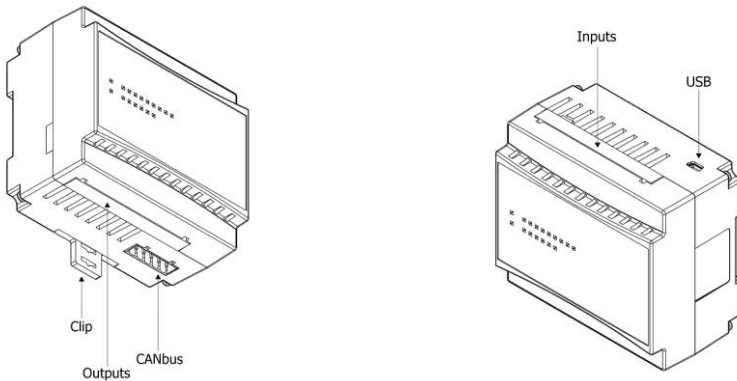

Alert Symbols and General Restrictions

This document uses the following alert symbols to highlight notices that must be observed in order to ensure personal safety and/or prevent property damages.

Symbol	Meaning	Description
	Danger	The identified danger causes physical and property damage.
	Warning	The identified danger could cause physical and property damage.
<i>Caution</i>	Caution	Use caution.

EXF-RC15 Installation Guide

- Before using this product, the user must read and understand this document.
- All examples and diagrams are intended to aid understanding, and do not guarantee operation. Unitronics accepts no responsibility for actual use of this product based on these examples.
- Please dispose of this product according to local and national standards and regulations.
- Only qualified service personnel should open this device or carry out repairs.



Failure to comply with appropriate safety guidelines can cause severe injury or property damage.



- Do not attempt to use this device with parameters that exceed permissible levels.
- Do not connect/disconnect the device when power is on.

Environmental Considerations



- Do not install in areas with: excessive or conductive dust, corrosive or flammable gas, moisture or rain, excessive heat, regular impact shocks or excessive vibration, in accordance with the standards given in the product's technical specification sheet.
- Do not place in water or let water leak onto the model.
- Do not allow debris to fall inside the model during installation.



- Ventilation: 10mm space required between model's top/bottom edges & enclosure walls.
- Install at maximum distance from high-voltage cables and power equipment.

DIN-rail Mounting

1. Snap the model onto the DIN rail as shown in the figure to the right.

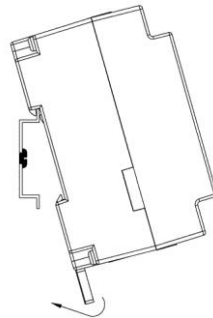

2. When properly mounted, the model is squarely situated on the DIN-rail as shown in the figure to the right.

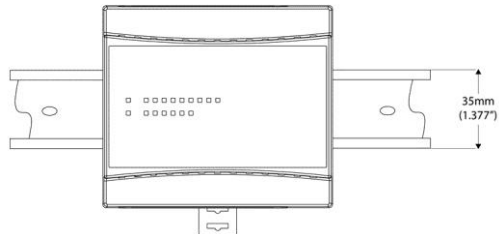

Setting the Unit ID Number

The module's CANbus Unit ID is defined by a specific System Integer that is dedicated for this purpose. Please refer to the Help Manual of the Visilogic software for detailed explanation and setup instructions.

Wiring



- Do not touch live wires.



- Install an external circuit breaker. Guard against short-circuiting in external wiring.
- Use appropriate circuit protection devices.
- Unused pins should not be connected. Ignoring this directive may damage the device.
- Double-check all wiring before turning on the power supply.

Caution

- To avoid damaging the wire, do not exceed a maximum torque of 0.5 N·m (5 kgf·cm).
- Do not use tin, solder, or any substance on stripped wire that might cause the wire strand to break.
- Install at maximum distance from high-voltage cables and power equipment.

Wiring Procedure

Use crimp terminals for wiring; use 3.31 mm² –0.13 mm² wire (12-16 AWG):

- Strip the wire to a length of 7±0.5mm (0.275±0.020”).
- Unscrew the terminal to its widest position before inserting a wire.
- Insert the wire completely into the terminal to ensure a proper connection.
- Tighten enough to keep the wire from pulling free.

- Input or output cables should not be run through the same multi-core cable or share the same wire.
- Allow for voltage drop and noise interference with I/O lines used over an extended distance. Use wire that is properly sized for the load.
- The model and I/O signals must be connected to the same 0V signal.

I/Os

This model comprises a total of 9 digital inputs, 2 relay outputs and 4 npn (sink) outputs. Input functionality can be adapted as follows:

- The digital inputs may be wired, in one group, and set to either npn or pnp via wiring.

In addition, according to appropriate wiring:

- Inputs 0, 2, and 4 can function as high-speed counters, as part of a shaft-encoder, or as normal digital inputs.
- Inputs 1, 3, and 5 can function as either counter reset, as part of a shaft-encoder, or as normal digital inputs.
- If inputs 0, 2 and 4 are set as high-speed counters (without reset), inputs 1, 3 and 5 can function as normal digital inputs.

I/O Wiring

I/O Configuration

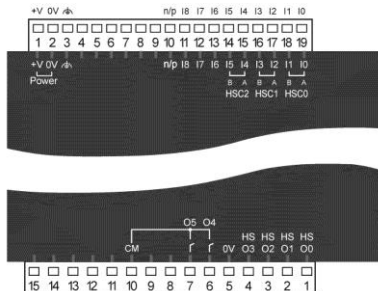

nnp Input Wiring

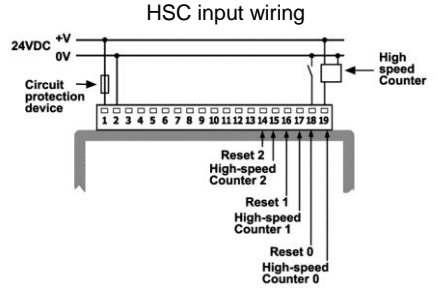
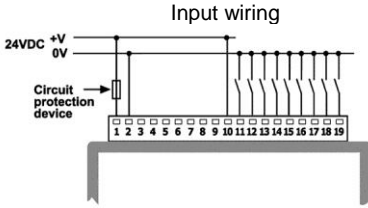

pnp Input Wiring

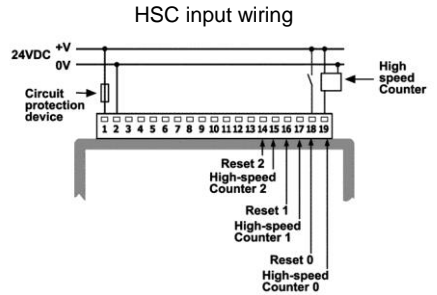
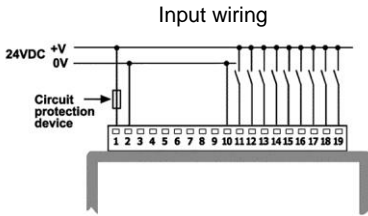

Shaft-encoder Input Wiring

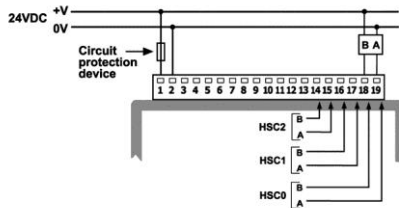

nnp Outputs Wiring

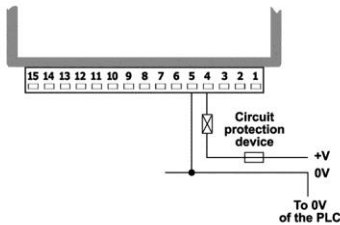

Relay Outputs

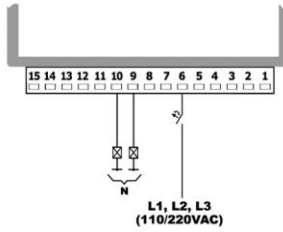

Increasing Contact Life Span

To increase the life span of the relay output contacts and protect the device from potential damage by reverse EMF, connect:

- A clamping diode in parallel with each inductive DC load
- An RC snubber circuit in parallel with each inductive AC load

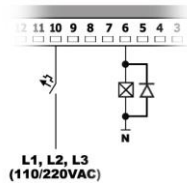
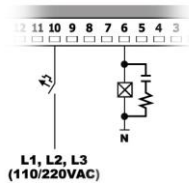

Power Supply

The model requires an external 24VDC power supply.



- The power supply must include double insulation. Outputs must be rated as SELV/PELV/Class 2/Limited Power.

- Use separate wires to connect the functional earth line (pin 3) and the 0V line (pin 2) to the system earth ground.
- Install an external circuit breaker. Guard against short-circuiting in external wiring.



- Double-check all wiring before turning on the power supply.
- Do not connect either the 'Neutral' or 'Line' signal of the 110/220VAC to device's 0V pin.
- In the event of voltage fluctuations or non-conformity to voltage power supply specifications, connect the device to a regulated power supply.

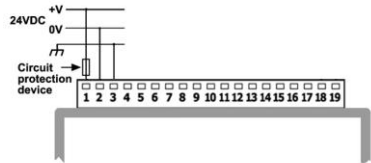

Earthing the model

To maximize system performance, avoid electromagnetic interference by:

- Mounting the model on a metal panel.
- Connect each common and ground connection directly to the earth ground of your system.

For ground wiring use the shortest and thickest possible wire.

Communication Port



- Turn off power before making communications connections.

USB Device

Use for application download and direct PC-EXF-RC15 communication.

CANbus

Use the CANbus port for all CANbus communications including integration. The EXF-RC15 is shipped with a 5 pin CANbus terminal block.

CANbus Wiring

Use twisted-pair cable. DeviceNet® thick shielded twisted pair cable is recommended.

Network terminators: These are supplied with the model. Place terminators at each end of the CANbus network.

Resistance must be set to 1%, 121Ω, 1/4W.

Connect ground signal to the earth at only one point, near the power supply.

- The network power supply need not be at the end of the network.

CANbus Connector

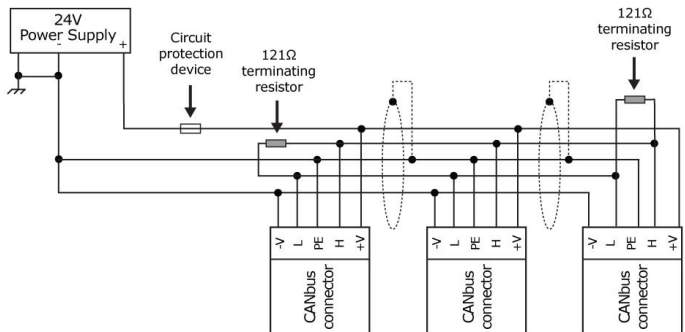

The information in this document reflects products at the date of printing. Unitronics reserves the right, subject to all applicable laws, at any time, at its sole discretion, and without notice, to discontinue or change the features, designs, materials and other specifications of its products, and to either permanently or temporarily withdraw any of the forgoing from the market.

All information in this document is provided "as is" without warranty of any kind, either expressed or implied, including but not limited to any implied warranties of merchantability, fitness for a particular purpose, or non-infringement. Unitronics assumes no responsibility for errors or omissions in the information presented in this document. In no event shall Unitronics be liable for any special, incidental, indirect or consequential damages of any kind, or any damages whatsoever arising out of or in connection with the use or performance of this information.

The tradenames, trademarks, logos and service marks presented in this document, including their design, are the property of Unitronics (1989) (R"G) Ltd. or other third parties and you are not permitted to use them without the prior written consent of Unitronics or such third party as may own them